



M. S. Foster & Associates, Inc.

1866 N. Country Lane, Michigan City, IN 46360
Phone 219-380-3266 or 219-879-9225 • Toll Free 888-452-4053
Fax 219-879-9313 • email: sales@msfoster.com
www.msfoster.com



COUGAR
INDUSTRIES, INC.

MOBILE/TRUCK VIBRATORS



THE PIONEER IN TRUCK VIBRATORS

Patented the World's First 12-Volt Truck Vibrator in 1964

Forged the most rugged, reliable truck vibrators on the market

CONTENTS & HISTORY



- 2** ▶ **History**
- 3-4** ▶ **Why use Cougar Vibrators**
- 5-6** ▶ **Mobile/Truck Vibrator Selection**
- 7-8** ▶ **Mobile/Truck Accessories**
- 9** ▶ **Specifications**
- 10** ▶ **Warranty**

Patented the V

THE PIONEER



The Leader in Industrial Vibration

Cougar Industries, Inc. patented the world's first 12-volt truck vibrator in 1964. Since that time, industrial vibrators have been our central focus and have made the Cougar name synonymous with exceptional quality products, workmanship and service support. Our heavy-duty vibrator product lines reflect our on-going commitment to provide our customers with the most rugged and reliable industrial vibrators on the market today.

Whether designed at our facility in Peru, IL, or a result of an acquisition of a complimentary brand such as Northern Vibrator and Branford Vibrator, we provide a complete range of flow-aid products including rotary electric and hydraulic, pneumatic piston, ball, ring and turbine industrial vibrators; air cannons; bin aerators; and heavy-duty storage bin cleaning devices such as the Gyro-Whip and Power Lance. Cougar products are currently performing on stationary vibratory tables, compactors, feeders, hoppers and dribble chutes as well as a wide range of truck, rail car, concrete and construction applications all over the world.

Let Cougar's experienced personnel recommend the right device to keep your material moving.

The World's First 12-Volt Truck Vibrator in 1964

Forged the most rugged, reliable truck vibrators on the market

THE PIONEER IN TRUCK VIBRATORS



WHY USE COUGAR VIBRATORS?

Cougar's complete line of rugged, durable Truck Vibrators offers the following features that make us the leader in Truck Vibrators by providing:

- ▶ **Easy, low-cost installation.**
- ▶ **Shielded, oversized, permanently lubricated ball bearings that assure exceptional service life.**
- ▶ **Sealed against dirt, dust, and water for long life in extreme conditions.**
- ▶ **Small size and weight with high-speed, low-amp electric motors.**



Patented the
PIONEER



With 45 years of quality, reliable performance and service in the Truck Vibrator business, we are the leaders in understanding what evidence shows that you need a Cougar Vibrator on your mobile product.

- 1 Repairs needed on truck brakes**
- 2 Repairs needed to damaged truck clutches**
- 3 Truck transmission problems**
- 4 Damage to tailgates from rocking the truck to empty the load**
- 5 Damage to truck bed surfaces from backhoes removing material not dumped**

Adding a Cougar Truck Vibrator not only will save you money on costly repairs to your trucks, it will increase productivity by eliminating carry-back. This will give you more payload per cycle and fewer cycles per job. Fewer cycles in return will give you lower labor and fuel costs and decrease your vehicle wear. Other benefits will be the material being evenly distributed when spreading. You will save elimination of bed cleanout time and lower workman compensation claims by personnel because they will no longer be required to climb into the truck beds for clean out.

the World's First 12-Volt Truck Vibrator in 1964
Forged the most rugged, reliable truck vibrators on the market
THE PIONEER IN TRUCK VIBRATORS





























MOBILE/TRUCK VIBRATOR SELECTION

		DUMP TRUCK			DUMP TRUCK TANDEM LIVE BOTTOM	SPREADERS SLIDE-IN	SPREADERS MOUNTED
		1-5 Yards	5-10 Yards	10-15 Yards	15-30 Yards	5-10 Yards	5-10 Yards
	DC 3200			X	X		X
	DC 2500		X			X	X
	DC 1100	X					
	DC1-400						
	DC 200						
	DC 80						
	NHD-110 <i>Hydraulic</i>			X	X		
	5016 <i>Pneumatic</i>						
	ATU-43						

SPREADERS TAILGATE OR ATV		CONCRETE PUMPER	SANITATION, PUMPER, AND VACUUM TRUCKS	VOLUMETRIC MIXERS	MIXER TRUCKS
.2-2 Yards	2-4 Yards				
			X		
			X		
		X			
	X				
X					X
			X		
				X	
					X

MOBILE/TRUCK ACCESSORIES

COUGAR TRUCK VIBRATOR MODELS						
	TIMER 12 VOLT P/N 197266 <i>Runs 45 secs on 90 secs off</i>	TIMER 12 VOLT P/N 197266-01 <i>5 secs on resets after 10 secs</i>	TIMER 12 VOLT ADJUSTABLE P/N 197265 <i>1-100 secs on 1-100 secs off (24 Volt Timer Available)</i>	CIRCUIT BREAKER 12 VOLT P/N 193215	CIRCUIT BREAKER 24 VOLT P/N 193218	TRUCK MOUNT KIT 12 VOLT P/N 221615
DC 80	X	X	X			
DC 200	X	X	X			
DC 1100	X	X	X	X	X	
DC 2500	X	X	X	X	X	
DC 3200	X	X	X	X	X	
DC1-400	X	X	X	X	X	X
COUGAR TRUCK VIBRATOR MODELS						
	CONTROL KIT P/N 196854-01	12 VOLT MOUNT KIT P/N 221614	24 VOLT MOUNT KIT P/N 221619	MOUNT PLATES P/N 220505	MOUNT PLATES P/N 220491-01	MOUNT PLATES P/N 220525
DC 80	X				X	
DC 200	X				X	
DC 1100						X
DC 2500						X
DC 3200						
DC1-400		X	X	X		
NHD-110						

						
TRUCK MOUNT KIT 24 VOLT P/N 221616	TRUCK MOUNT KIT 12 VOLT P/N 221611	TRUCK MOUNT KIT 24 VOLT P/N 221624	TRUCK MOUNT KIT 12 VOLT P/N 221625	TRUCK MOUNT KIT 24 VOLT P/N 221623	TRUCK MOUNT KIT 12 VOLT ALUMINUM P/N 221617	TRUCK MOUNT KIT 12 VOLT ALUMINUM P/N 221618
	X	X			X	
	X	X			X	
			X	X		X
X						
						
MOUNT PLATE P/N 220526	MOUNT PLATES ALUMINUM P/N 220581	MOUNT PLATES ALUMINUM P/N 220582	TRAILER CONNECTOR PLUG P/N 194996	TRAILER CONNECTOR SOCKET P/N 194997	TRUCK CABLE PER FOOT P/N 195103 <i>(Must Specify Length)</i>	TRUCK CABLE PER FOOT P/N 195109 <i>(Must Specify Length)</i>
	X		X	X	X	
	X		X	X	X	
X		X	X	X	X	
						X
X		X				

SPECIFICATIONS & WARRANTY

12/24 Volt DC Performance

Model	In. Lbs.	VPM	Force Lbs.	Amps (12V)	Amps (24V)
DC-3200	7.00	4,000	3,200	85	62
DC-2500	3.50	5,000	2,500	72	55
DC-1100	1.50	5,000	1,000	70	55
DC1-400	1.00	3,800	410	15	7
DC-200	0.36	4,500	200	5	--
DC-80	0.18	4,000	80	5	--

12/24 Volt DC Dimensions (Inch)

Model	A	B	C	D	E	F	Weight Lbs
DC-3200	10 3/8"	9 3/4"	6 7/8"	2"	8"	5/8" x 1 3/4"	36
DC-2500	10"	9 3/4"	6 7/8"	-	8"	5/8" x 1 3/4"	31
DC-1100	10"	9 3/4"	6 7/8"	-	8"	5/8" x 1 3/4"	30
DC1-400	9 1/16"	6 3/8"	5 9/16"	3 3/4"	5"	3/8" x 1 1/2"	18
DC-200	5 11/16"	5"	3 7/16"	2"	4"	3/8" x 1 1/4"	5
DC-80	5 11/16"	5"	3 7/16"	2"	4"	3/8" x 1 1/4"	5

Hydraulic Truck Performance

Model	In Lbs.	VPM	Force Lbs.	GPM	VPM	Force Lbs.	GPM	VPM	Force Lbs.	GPM	Max PSI
NHD 110	6.00	2,000	681	2.0	3,000	1,534	2.8	4,000	2,726	3.5	2,000

Hydraulic Truck Dimensions

Model	A	B	C	D	E	F	G	Weight Lbs
NHD 110	7 1/2"	10"	8 5/8"	2"	8"	5/8"	3/4-16 SAE	37

Piston/Turbine Air Performance (Inch)

Model	Piston Size In	40 PSI		60 PSI		MAX 80 PSI	
		VPM	CFM	VPM	CFM	VPM	CFM
5016	2	2600	11	3900	16.1	4100	20.9
ATU-43	-	-	-	11700	9.4	13000	11.7

Piston/Turbine Dimensions (Inch)

Model	Piston Size In	Bolt			Port NPT	Weight Lbs		
		A	B	C				
5016	2"	7 1/2"	3 1/2"	7"	6"	5/8"	1/4"	20
ATU-43	-	5 3/4"	2 1/4"	3 5/32"	4"	3/8"	1/4"	3

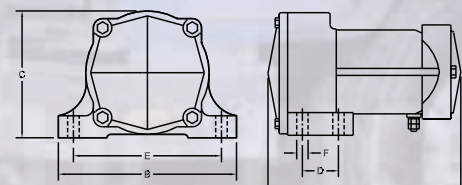
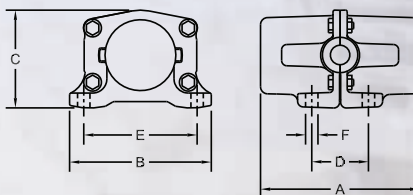
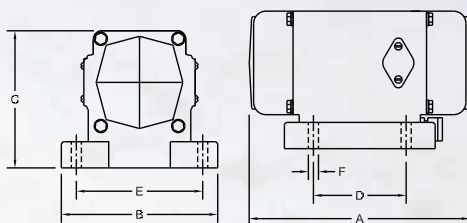
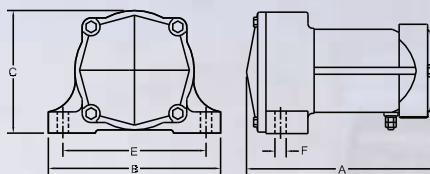
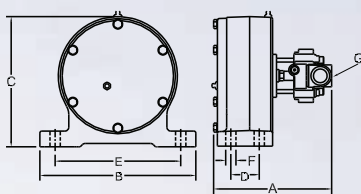
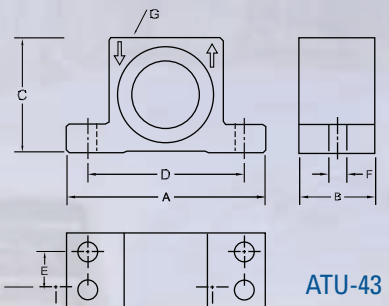
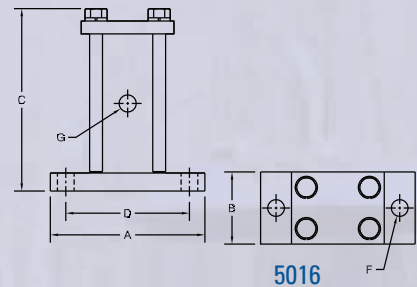

Exceptional Extended Truck & Mobile Limited Warranty

Cougar Industries, Inc. will repair or replace, at its option, any Truck or Mobile product which has been found to be defective within the **FIRST** 12 month limited warranty period, provided that the product is shipped, with pre-approved factory authorization, freight prepaid, to the plant in Peru, Illinois, U.S.A. A **NEW** 12 month limited warranty period will commence from the shipment date of any repaired or replacement Truck or Mobile product. **Cougar Industries, Inc.** is not responsible for removal, installation, or any other incidental expenses incurred in shipping the products to or from **Cougar Industries, Inc.**

This limited warranty shall be in effect for a period of twelve months from the date of sale. This warranty shall be lieu of any other warranty, express or implied, including, but not limited to, any implied warranty of merchantability or fitness for a particular purpose.

Cougar Industries, Inc. liability under this warranty shall be solely limited to the repair or replacement of the Truck or Mobile products within the warranty period, and **Cougar Industries, Inc.** shall not be liable, under any circumstances, for consequential or incidental damages, including, but not limited to, personal injury or labor costs.

Cougar Industries, Inc. guarantees all Truck & Mobile products manufactured by it to be free from defects in workmanship and materials when operated in accordance with nameplate characteristic limits. Truck & Mobile Products must be installed and maintained in accordance with **Cougar Industries, Inc.** instructions. Users are responsible for the suitability of the products to their application. There is no warranty against damage resulting from misapplication, improper specifications, or other operating conditions beyond our control. Claims against carriers for damage in transit must be filed by the buyer.

Under no circumstances will **Cougar Industries, Inc.** be responsible for any expense in connection with any repairs made by anyone other than the factory or an authorized service station, unless such repairs have been specifically authorized in writing.

Patented the World's First 12-Volt Truck Vibrator in 1964
Forged the most rugged, reliable truck vibrators on the market

THE PIONEER IN TRUCK VIBRATORS



Cougar Industries, Inc. manufactures a complete line of industrial vibrators to solve your material flow problems.

Contact us for a FREE evaluation and recommendation.



Ball Vibrators



Turbine Vibrators



Electric Vibrators



Air/Hydraulic Vibrators



Piston Vibrators

3600 Cougar Drive,
Peru, Illinois 61354-9336
www.cougarindustries.com

Toll Free: 800-262-2106
Phone: 815-224-1200
Fax: 815-224-1241



M. S. Foster & Associates, Inc.

1866 N. Country Lane, Michigan City, IN 46360
Phone 219-380-3266 or 219-879-9225 • Toll Free 888-452-4053
Fax 219-879-9313 • email: sales@msfoster.com
www.msfoster.com