

LED Snow Plow Lights - Model 9900 LP

PRODUCT INFORMATION

Description	12-24V DOT/ECE RHT Heated Low Profile Headlight - 2 Light Kit
Height	83.00 mm / 3.27 in
Width	334.00 mm / 13.15 in
Depth	85.00 mm / 3.35 in
Shape	Rectangular
Outer Lens Material	Polycarbonate
Outer Lens Color	Clear
Housing Material	Aluminum
Housing Color	Black
Bezel Color	Black
Mounting Hardware Description	(x2) M8-1.25 x 25mm SS Carriage Bolt
Mounting Type	Universal Pedestal Mount
Retrofits	Pedestal mount snow plow lights
Minimum Operating Temperature	-30 °C / -22 °F
Maximum Operating Temperature	55 °C / 131 °F
Connector or Wiring	6-Pin Delphi (#12052848)
Mating Connector	Delphi (#12052848)
Product Weight	1.20 lbs / 0.54 kgs
Shipping Weight	6.25 lbs / 2.83 kgs

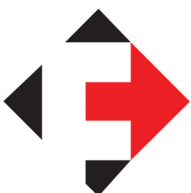
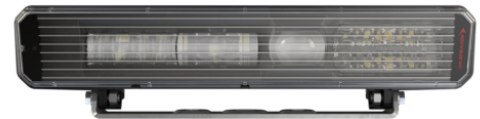
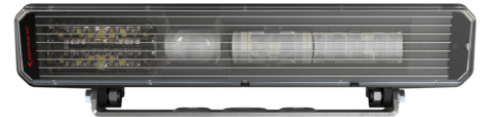

MS FOSTER

SERVING THE TRANSPORTATION INDUSTRY

1866 North Country Lane
Michigan City, IN 46360

OFFICE 219.879.9225
TOLL FREE 888.452.4053
FAX 219.879.9313

sales@msfoster.com
www.msfooster.com

LED Snow Plow Lights - Model 9900 LP

PRODUCT DIMENSIONS

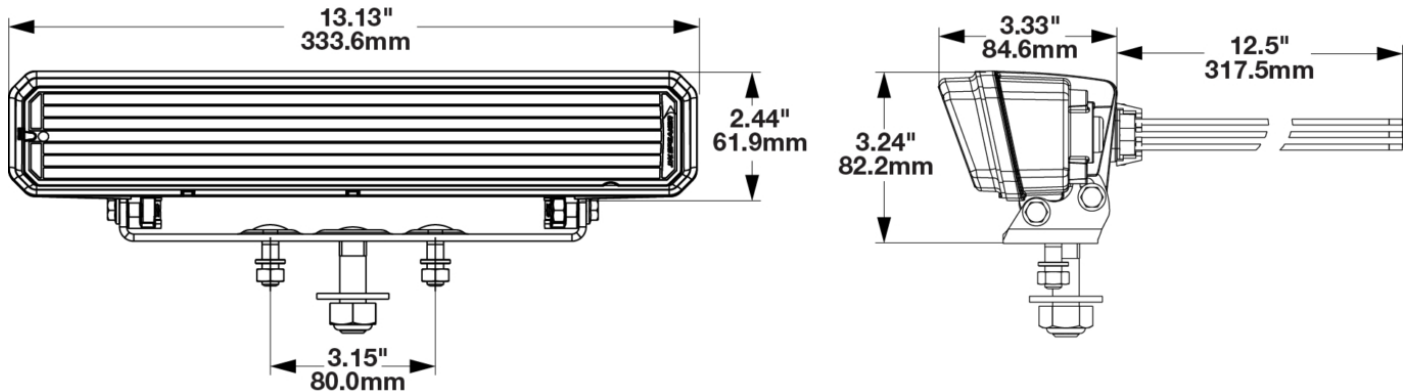

ELECTRICAL SPECIFICATIONS

Input Voltage	12-24V DC
Operating Voltage	9-30V DC
Transient Spike Protection	150V Peak @ 1 HZ-100 Pulses
Red Wire	Front Position
Black Wire	Ground
White Wire	High Beam
Yellow Wire	Low Beam
Blue Wire	DRL
Orange Wire	Turn
Current Draw	5.00A @ 12V DC (High Beam) 3.50A @ 12V DC (Low Beam) 2.00A @ 12V DC (Front Position) 2.50A @ 12V DC (DRL) 1.20A @ 12V DC (Turn) 3.00A @ 24V DC (High Beam) 2.25A @ 24V DC (Low Beam) 1.50A @ 24V DC (Front Position) 1.75A @ 24V DC (DRL) 0.75A @ 24V DC (Turn)

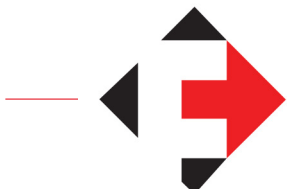

MS FOSTER

SERVING THE TRANSPORTATION INDUSTRY

1866 North Country Lane
Michigan City, IN 46360

OFFICE 219.879.9225
TOLL FREE 888.452.4053
FAX 219.879.9313

sales@msfoster.com
www.msfooster.com

LED Snow Plow Lights - Model 9900 LP

REGULATORY STANDARDS COMPLIANCE



Buy America Standards	ECE Reg 112
ECE Reg 6	ECE Reg 7
ECE Reg 87	Eco Friendly
FMVSS 108 Table VI	FMVSS 108 Table XIV
FMVSS 108 Table XIX	FMVSS 108 Table XVIII
SAE J2087	SAE J222
Tested to ECE Reg. 10 (Radiated Emissions only)	

PHOTOMETRIC SPECIFICATIONS

Raw Lumen Output	4,300 (High Beam); 2,370 (Low)
Effective Lumen Output	1,060 (High Beam); 587 (Low)
Candela Output	58,000
Beam Pattern(s)	Forward Lighting - Daytime Running Light Forward Lighting - High Beam (DOT/ECE) Forward Lighting - Low Beam (ECE Right Hand) Forward Lighting - Low Beam (DOT/ECE) Signalization - Front Position Signalization - Turn (Front)

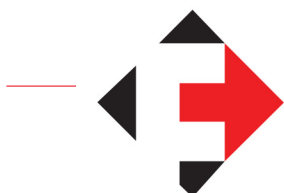
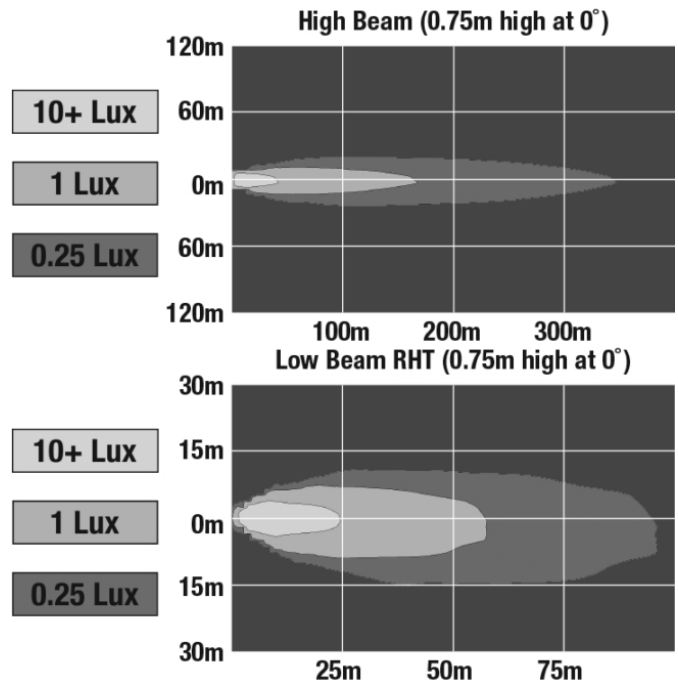

MS FOSTER

SERVING THE TRANSPORTATION INDUSTRY

1866 North Country Lane
Michigan City, IN 46360

OFFICE 219.879.9225
TOLL FREE 888.452.4053
FAX 219.879.9313

sales@msfoster.com
www.msfoster.com

LED Snow Plow Lights - Model 9900 LP

APPLICATIONS



INSTALLATION & APPLICATION INFORMATION

Each kit includes 2 lamps: a "LH" left hand lamp and a "RH" right hand lamp. This refers to installing the correct light on the left hand or right hand side of your vehicle, Pedestal mount snow plow lights for single or double bolt mounts. Each lamp comes with mounting hardware for single bolt mount included (1/2-13 x 1.75 SS Carriage Bolt with hex nut and washer), in addition to the 2 M8-1.25 x 25 SS Carriage Bolts for double bolt mounts.

SMARTHEAT™ HEATING SYSTEM

The SmartHeat™ heating system senses ambient temperature and turns the integrated heating system in the lens on & off. This system actually clears ice & snow twice as fast as conventional halogen lamps.

When does the heater turn on?

Heater turns on or off according to temperature changes and vehicle power:

- Heater will turn on when temperatures drop, generating enough heat to prevent ice build-up.
- Heater will turn on when powering up, de-icing the light as rapidly as possible.

When does the heater turn off?

Heater will turn off when it senses temperatures increase and are above the high temperature threshold.

Learn more about this technology [here](#).

See Additional Information on page 1 for heated wire installation



1866 North Country Lane
Michigan City, IN 46360

OFFICE 219.879.9225

TOLL FREE 888.452.4053

FAX 219.879.9313

sales@msfoster.com

www.msfoster.com

LED Snow Plow Lights - Model 9900 LP

RELATED PRODUCTS



Part Number

0556383

12-24V ECE LHT
Heated Low Profile
Headlight - 2 Light Kit



MS FOSTER

SERVING THE TRANSPORTATION INDUSTRY

1866 North Country Lane
Michigan City, IN 46360

OFFICE 219.879.9225

TOLL FREE 888.452.4053

FAX 219.879.9313

sales@msfoster.com

www.msfoster.com