

# LED Snow Plow Lights - Model 9900 LP

## PRODUCT INFORMATION

<b>Description</b>	12-24V DOT/ECE RHT Heated Low Profile Headlight - 2 Light Kit
<b>Height</b>	83.00 mm / 3.27 in
<b>Width</b>	334.00 mm / 13.15 in
<b>Depth</b>	85.00 mm / 3.35 in
<b>Shape</b>	Rectangular
<b>Outer Lens Material</b>	Polycarbonate
<b>Outer Lens Color</b>	Clear
<b>Housing Material</b>	Aluminum
<b>Housing Color</b>	Black
<b>Bezel Color</b>	Black
<b>Mounting Hardware Description</b>	(x2) M8-1.25 x 25mm SS Carriage Bolt
<b>Mounting Type</b>	Universal Pedestal Mount
<b>Retrofits</b>	Pedestal mount snow plow lights
<b>Minimum Operating Temperature</b>	-30 °C / -22 °F
<b>Maximum Operating Temperature</b>	55 °C / 131 °F
<b>Connector or Wiring</b>	6-Pin Delphi (#12052848)
<b>Mating Connector</b>	Delphi (#12052848)
<b>Product Weight</b>	1.20 lbs / 0.54 kgs
<b>Shipping Weight</b>	6.25 lbs / 2.83 kgs

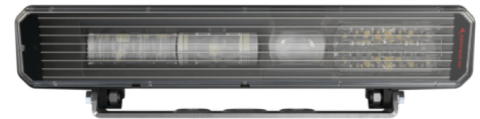
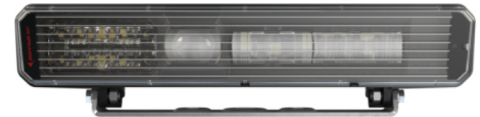

# MS FOSTER

SERVING THE TRANSPORTATION INDUSTRY

1040 HIGHWAY 212  
Michigan City, IN 46360

OFFICE 219.879.9225  
TOLL FREE 888.452.4053  
FAX 219.879.9313

sales@msfoster.com  
www.msfooster.com

# LED Snow Plow Lights - Model 9900 LP

## PRODUCT DIMENSIONS

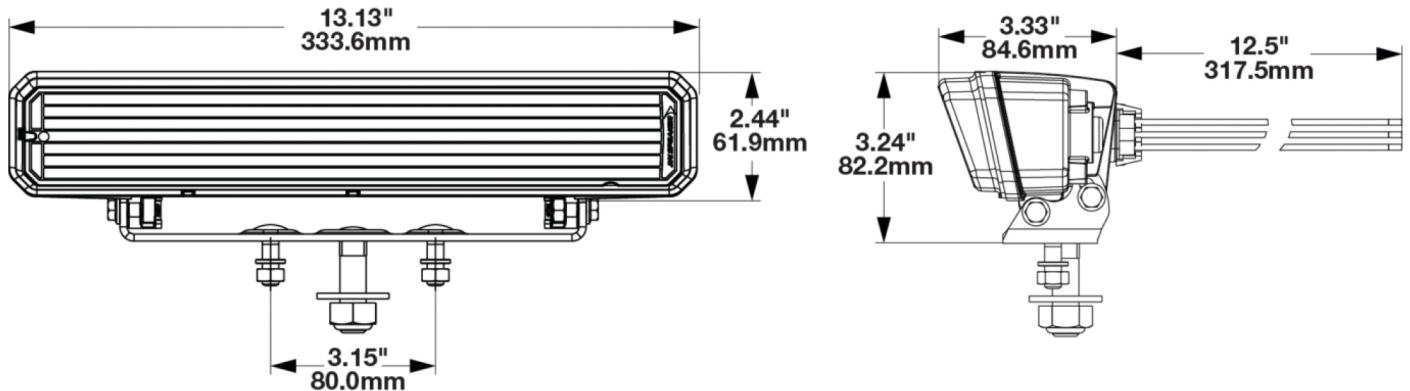

## ELECTRICAL SPECIFICATIONS

<b>Input Voltage</b>	12-24V DC
<b>Operating Voltage</b>	9-30V DC
<b>Transient Spike Protection</b>	150V Peak @ 1 HZ-100 Pulses
<b>Red Wire</b>	Front Position
<b>Black Wire</b>	Ground
<b>White Wire</b>	High Beam
<b>Yellow Wire</b>	Low Beam
<b>Blue Wire</b>	DRL
<b>Orange Wire</b>	Turn
<b>Current Draw</b>	5.00A @ 12V DC (High Beam) 3.50A @ 12V DC (Low Beam) 2.00A @ 12V DC (Front Position) 2.50A @ 12V DC (DRL) 1.20A @ 12V DC (Turn) 3.00A @ 24V DC (High Beam) 2.25A @ 24V DC (Low Beam) 1.50A @ 24V DC (Front Position) 1.75A @ 24V DC (DRL) 0.75A @ 24V DC (Turn)

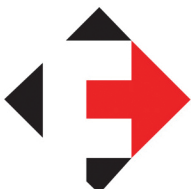

# MS FOSTER

SERVING THE TRANSPORTATION INDUSTRY

1040 HIGHWAY 212  
Michigan City, IN 46360

OFFICE 219.879.9225  
TOLL FREE 888.452.4053  
FAX 219.879.9313

sales@msfoster.com  
www.msfooster.com

# LED Snow Plow Lights - Model 9900 LP

## REGULATORY STANDARDS COMPLIANCE



Buy America Standards	ECE Reg 112
ECE Reg 6	ECE Reg 7
ECE Reg 87	Eco Friendly
FMVSS 108 Table VI	FMVSS 108 Table XIV
FMVSS 108 Table XIX	FMVSS 108 Table XVIII
SAE J2087	SAE J222
Tested to ECE Reg. 10 (Radiated Emissions only)	

## PHOTOMETRIC SPECIFICATIONS

<b>Raw Lumen Output</b>	4,300 (High Beam); 2,370 (Low)
<b>Effective Lumen Output</b>	1,060 (High Beam); 587 (Low)
<b>Candela Output</b>	58,000
<b>Beam Pattern(s)</b>	Forward Lighting - Daytime Running Light Forward Lighting - High Beam (DOT/ECE) Forward Lighting - Low Beam (ECE Right Hand) Forward Lighting - Low Beam (DOT/ECE) Signalization - Front Position Signalization - Turn (Front)

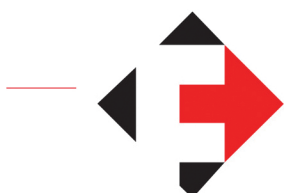
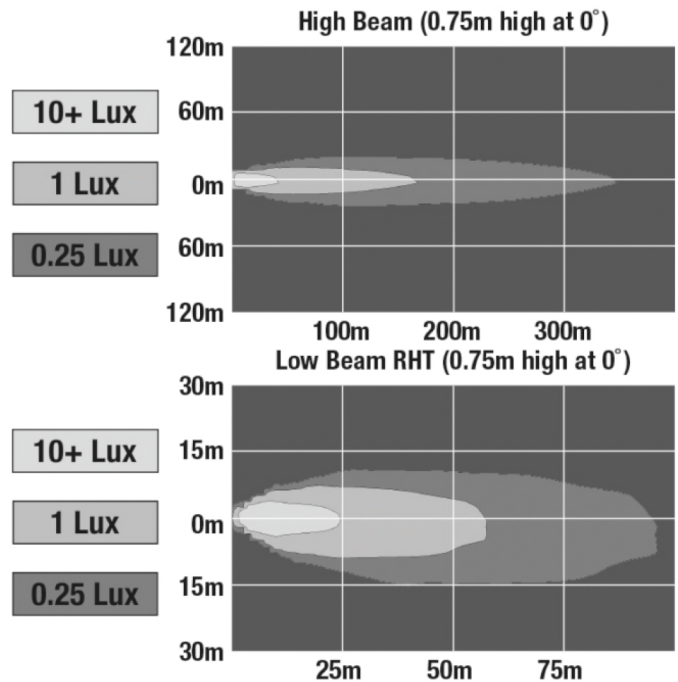

# MS FOSTER

SERVING THE TRANSPORTATION INDUSTRY

1040 HIGHWAY 212  
Michigan City, IN 46360  
OFFICE 219.879.9225  
TOLL FREE 888.452.4053  
FAX 219.879.9313  
sales@msfoster.com  
www.msfoster.com

# LED Snow Plow Lights - Model 9900 LP

## APPLICATIONS



## INSTALLATION & APPLICATION INFORMATION

Each kit includes 2 lamps: a "LH" left hand lamp and a "RH" right hand lamp. This refers to installing the correct light on the left hand or right hand side of your vehicle, Pedestal mount snow plow lights for single or double bolt mounts. Each lamp comes with mounting hardware for single bolt mount included (1/2-13 x 1.75 SS Carriage Bolt with hex nut and washer), in addition to the 2 M8-1.25 x 25 SS Carriage Bolts for double bolt mounts.

## SMARTHEAT™ HEATING SYSTEM

The SmartHeat™ heating system senses ambient temperature and turns the integrated heating system in the lens on & off. This system actually clears ice & snow twice as fast as conventional halogen lamps.

### When does the heater turn on?

Heater turns on or off according to temperature changes and vehicle power:

- Heater will turn on when temperatures drop, generating enough heat to prevent ice build-up.
- Heater will turn on when powering up, de-icing the light as rapidly as possible.

### When does the heater turn off?

Heater will turn off when it senses temperatures increase and are above the high temperature threshold.

Learn more about this technology [here](#).

See Additional Information on page 1 for heated wire installation

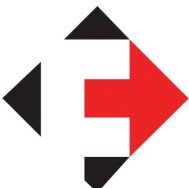

# MS FOSTER

SERVING THE TRANSPORTATION INDUSTRY

1040 HIGHWAY 212  
Michigan City, IN 46360

OFFICE 219.879.9225  
TOLL FREE 888.452.4053  
FAX 219.879.9313

sales@msfoster.com  
www.msfooster.com

# LED Snow Plow Lights - Model 9900 LP

## RELATED PRODUCTS

---



**Part Number**

**0556383**

12-24V ECE LHT  
Heated Low Profile  
Headlight - 2 Light Kit



# MS FOSTER

SERVING THE TRANSPORTATION INDUSTRY

1040 HIGHWAY 212  
Michigan City, IN 46360

OFFICE 219.879.9225  
TOLL FREE 888.452.4053  
FAX 219.879.9313

[sales@msfoster.com](mailto:sales@msfoster.com)  
[www.msfoster.com](http://www.msfoster.com)